

Drills

Offering a comprehensive range of industrial and professional grade drills and boring bits for the woodworking industry.

Drilling products include: Solid Carbide Drills, Machine Drill Adapters, Drilling Jigs, Lipped Brad Point Drills, Countersinks, Standard Brad Points, Forstner Bits, Hinge Boring Bits, Auger Bits, HSS Jobber Drills, Plug Cutters, Dowel Drills, Mortising Chisels and a complete line of Chuck Adapter Drills.

- Adapted carbide grade for extended tool life
- PTFE coated dowels and through hole drills
- Solid carbide drills

TBOX

Darbagaldi & Instrumenti

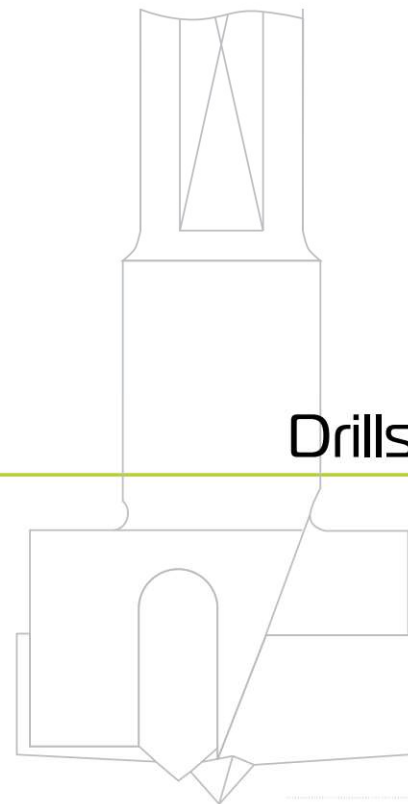

Drills INDEX

TBOX
Darbagaldi & Instrumenti

Illustrated Visual Index	196	-	197
Technical Information	198	-	
CNC & Automatic Drilling Machines	199	-	212
Multi-Purpose Boring	213		214
Countersink & Plug Maker	215	-	223
Dirose	224	-	225

Drills



CNC & Automatic Machines



Multi Purpose Boring



Slot Mortising



Counter Sinking & Plug maker



Dirose

Drills



Darbagaldi & Instrumenti

INDEX

201 Bk - Dowel Drill 57.5, 70mm	Professional Drills set for wood doweling and CNC machine	201 Bk - Dowel Drill 77, 85, 105mm	201 Bk - Dowel Drill - Double Flute 57.5mm	201 Bk - Dowel Drill Double Flute 70-77mm	201 Bk - Dowel Drill - Double Flute 8mm Shank 55.5, 67mm
199	199	200	201	202	203
201 Bk - Dowel Drill - for Mafell 8mm Shank 57.5mm	206 Bk - Dowel Drill extended life time 57.5, 70, 77mm	201 Bk - Through Hole Drilling 57.5mm	201 Bk - Through Hole Drilling 70mm	201 Bk - Through Hole Drilling 77mm	201 Bk - Through Hole Drilling 8mm Shank 55.5mm
203	204	205	205	206	206
Ditec™ Dowel Drill 57.5, 70mm	Ditec™ Through Hole Drilling 57.5, 70mm	Ditec™ - Solid Dowel Drill 57.5, 70mm	Ditec™ - Solid Carbide Through Hole Drill 57.5, 70mm	203 Bk - Cylinder Boring Bit - Combi System 57.5, 70, 77mm	203 T - Combi Chuck
207	207	208	208	209	210
Reduction Bushing for Combi Chuck	2039 - Chuck Adapter for Solid HM Or HSS Drills	2022 - Countersink for Dowel Drills	2034 Cylinder Boring Bit For Router Machine	203 BM - Adjustable Cylinder Boring Bit	203 BM - Adjustable Cylinder Boring Bit
211	211	212	212	213	213

Drills



CNC & Automatic Machines



Multi Purpose Boring



Slot Mortising



Counter Sinking & Plug maker



Dirose

Drills



Darbagaldi & Instrumenti

INDEX

203 B Cylinder Boring Bit	Countersink with Low friction Depth-Stop	Countersink with Low friction Depth-Stop	Countersink With Depth Stop-PRO	Countersink With Depth Stop-PRO	Carbide Tipped Countersink
214	216	216	217	217	218
Carbide Tipped Countersink	Carbide Tipped Countersink	Carbide Tipped Counterbore (flat bottom)	Carbide Tipped Countersink	Carbide Tipped Counterbore	3 Steps Drill for laminated chipboard
218	219	219	220	220	220
Dicount - Multi Diameter Countersink	Carbide Tipped Countersink	Plug Cutters - Self Ejecting	Countersink & Plug Set	Carbide Tipped Plug Cutters - 2 flutes	HSS Drills
221	221	221	222	222	223
HSS Taper Point Drills	HSS Stepped Drills	Dirose	Profile for Dirose.		
223	223	224	225		

Drills



CNC & Automatic Machines



Multi Purpose Boring



Slot Mortising











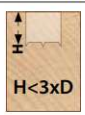
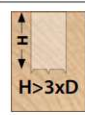

Counter Sinking & Plug maker



Dirose

Drills

DIMAR DRILLS SELECTION GUIDE

	Blind Holes		Through Hole	Life Time		Drilling Feed speed	
	 H < 3xD	 H > 3xD		Good	Excellent	Low	High
201 Dowel Drill for Blind Holes 	✓			✓		✓	
201 Dowel Drill Double Flute 		✓		✓		✓	
201 Through Hole Drill 			✓	✓		✓	
201 Dowel Drill - Extended Life Time 	✓				✓	✓	
201 Ditec Dowel Drills 	✓			✓	✓		
201 Ditec Through Hole Drills 			✓	✓	✓		
206 Ditec Solid Carbide - Dowell Drills 	✓			✓		✓	
206 Ditec Solid Carbide through Hole Drills 			✓	✓		✓	

Drills

CNC & Automatic Machines

201 Bk - Dowel Drill

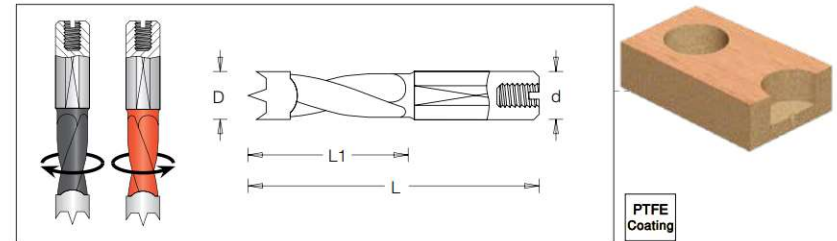

øD	Code No.		L1	L	ød
	Right	Left			
4.0	2012817	2012827	27	57.5	10x27
5.0	2010017	2010047	27	57.5	10x27
5.1	2010057	2010067	27	57.5	10x27
5.2	2010207	2010217	27	57.5	10x27
6.0	2010077	2010107	27	57.5	10x27
7.0	2010087	2010117	27	57.5	10x27
8.0	2010137	2010167	27	57.5	10x27
8.2	2010297	2010307	27	57.5	10x27
9.0	2010157	2010177	27	57.5	10x27
10.0	2010197	2010227	27	57.5	10x27
12.0	2010257	2010287	27	57.5	10x27

øD	Code No.		L1	L	ød
	Right	Left			
4.0	2012877	2012887	35	70	10x30
5.0	2010317	2010347	35	70	10x30
5.1	2010357	2010367	35	70	10x30
5.2	2012747	2012757	35	70	10x30
6.0	2010377	2010407	35	70	10x30
7.0	2010387	2010417	35	70	10x30
8.0	2010437	2010467	35	70	10x30
8.2	2012327	2012337	35	70	10x30
9.0	2010477	2010487	35	70	10x30
10.0	2010497	2010527	35	70	10x30
11.0	2010627	2010637	35	70	10x30
12.0	2010557	2010587	35	70	10x30



Professional Drills set for wood doweling and CNC machines. Cat. No. 75006/7

The Ultimate set for boring all types of wood

The set includes either 57.7mm or 70mm length 20pcs R/L Dowel Drills (see table above) together with two types of Cylinder Boring Bit- Combi system- items 2031007, 2031257



Drills



CNC & Automatic Machines



Multi Purpose Boring



Slot Mortising



Counter Sinking & Plug maker



Dirose

Drills



CNC & Automatic Machines



Multi Purpose Boring



Slot Mortising



Counter Sinking & Plug maker



Dirose

Drills

CNC & Automatic Machines

201 Bk - Dowel Drill

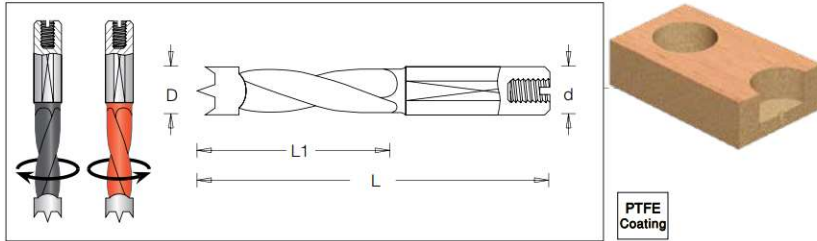

øD	Code No.		L1	L	ød
	Right	Left			
5.0	2012027	2012037	44	77	10x30
5.2	2012047	2012057	44	77	10x30
6.0	2012067	2012077	44	77	10x30
7.0	2012087		44	77	10x30
8.0	2012107	2012117	44	77	10x30
8.2	2012427	2012437	44	77	10x30
9.0	2012507	2012517	44	77	10x30
10.0	2012147	2012157	44	77	10x30
12.0	2012187	2012197	44	77	10x30

øD	Code No.		L1	L	ød
	Right	Left			
5.0	2019107	2019117	50	85	10x30
6.0	2019147	2019157	50	85	10x30
7.0	2019187	2019197	50	85	10x30
8.0	2019227	2019237	50	85	10x30
10.0	2019267	2019277	50	85	10x30



Drills

CNC & Automatic Machines

201 Bk - Dowel Drill - Double Flute

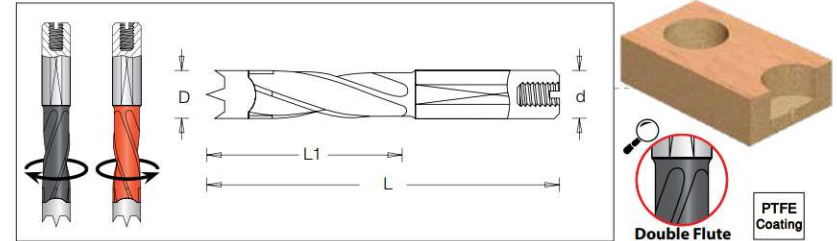

øD	Code No.		L1	L	ød
	Right	Left			
4.0	2014017	2014027	30	57.5	10x20
5.0	2014037	2014067	30	57.5	10x20
5.2	2014647	2014657	30	57.5	10x20
6.0	2014077	2014107	30	57.5	10x20
6.3	2014717	2014727	30	57.5	10x20
7.0	2014117	2014127	30	57.5	10x20
8.0	2014137	2014167	30	57.5	10x20
8.1	2015037	2015047	30	57.5	10x20
8.2	2015057	2015067	30	57.5	10x20
9.5	2015207		30	57.5	10x20
10.0	2014177	2014207	30	57.5	10x20
11.0	2015307	2015317	30	57.5	10x20
12.0	2014217	2014247	30	57.5	10x20
12.7	2015407	2015417	30	57.5	10x20
13.0	2015427	2015437	30	57.5	10x20
14.0	2015787	2015797	30	57.5	10x20
15.0	2015807	2015817	30	57.5	10x20
16.0	2015907	2015917	30	57.5	10x20

Available upon request



Drills

CNC & Automatic Machines

201 Bk - Dowel Drill - Double Flute

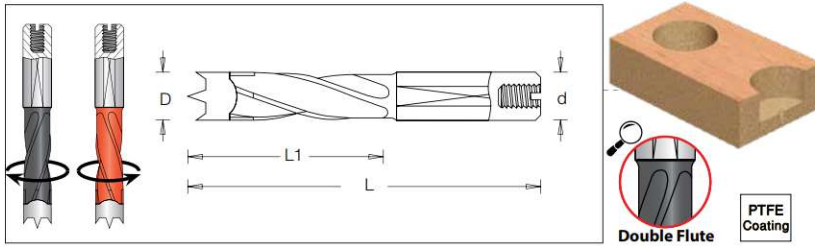

øD	Code No.		L1	L	ød
	Right	Left			
4.0	2014327	2014347	43	70	10x20
5.0	2014337	2014367	43	70	10x20
5.1	2014287	2014297	43	70	10x20
5.2	2014307	2014317	43	70	10x20
6.0	2014377	2014407	43	70	10x20
6.3	2014587	2014597	43	70	10x20
7.0	2014417	2014427	43	70	10x20
8.0	2014437	2014467	43	70	10x20
8.1	2014877	2014887	43	70	10x20
8.2	2014897	2014907	43	70	10x20
9.0	2014917	2014927	43	70	10x20
9.5	2014937	2014947	43	70	10x20
10.0	2014477	2014507	43	70	10x20
11.0	2014487	2014557	43	70	10x20
12.0	2014517	2014547	43	70	10x20
12.7	2014567	2014577	43	70	10x20
14.0	2015947	2015957	43	70	10x20
15.0	2015967	2015977	43	70	10x20
16.0	2015987	2015997	43	70	10x20

øD	Code No.		L1	L	ød
	Right	Left			
5.0	2014737	2014767	50	77	10x20
6.0	2014777	2014787	50	77	10x20
8.0	2014837	2014867	50	77	10x20
8.2	2015547	2015557	50	77	10x20
10.0	2014957	2014967	50	77	10x20
11.0	2015707	2015717	50	77	10x20
12.0	2014977	2014987	50	77	10x20



Screw
#193 000 0
M5x10

TBOX

Darbagaldi & Instrumenti

Drills

CNC & Automatic Machines

201 Bk - Dowel Drill - Double Flute 8mm Shank

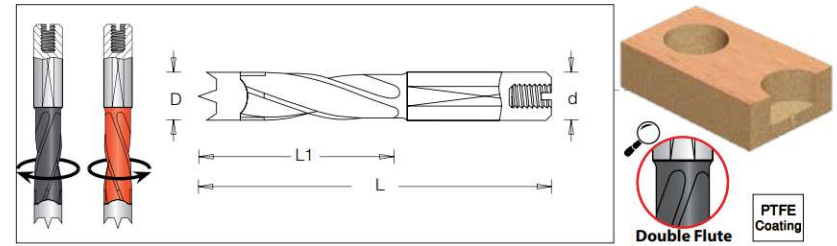

øD	Code No.		L1	L	ød
	Right	Left			
5.0	2014035	2014065	30	55.5	8x20
6.0	2014075	2014105	30	55.5	8x20
8.0	2014135	2014165	30	55.5	8x20
10.0	2014175	2014205	30	55.5	8x20
12.0	2014215	2014245	30	55.5	8x20

øD	Code No.		L1	L	ød
	Right	Left			
5	2014335	2014365	40	67.0	8x20
6	2014375	2014405	40	67.0	8x20
8	2014435	2014465	40	67.0	8x20
9	2014915	2014925	40	67.0	8x20
10	2014475		40	67.0	8x20
12	2014515	2014545	40	67.0	8x20



Screw
#193 000 0
M5x10

201 Bk - Dowel Drill - for Mafell Machine 8mm Shank

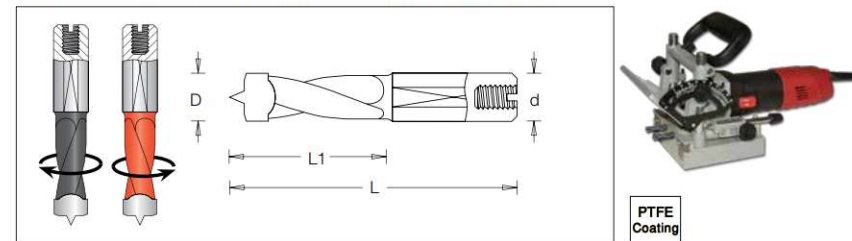

øD	Cod. No.	L1	L	ød
6.0	2013815	37	57.5	8x20
8.0	2013835	37	57.5	8x20
10.0	2013855	37	57.5	8x20
12.0	2013875	37	57.5	8x20

Drills



CNC & Automatic Machines



Multi Purpose Boring



Slot Mortising



Counter Sinking & Plug maker



Dirose

Drills



CNC & Automatic Machines



Multi Purpose Boring



Slot Mortising



Counter Sinking & Plug maker



Dirose

Drills



Darbagaldi & Instrumenti

CNC & Automatic Machines

206 Bk - Dowel Drill Extended Life-Time

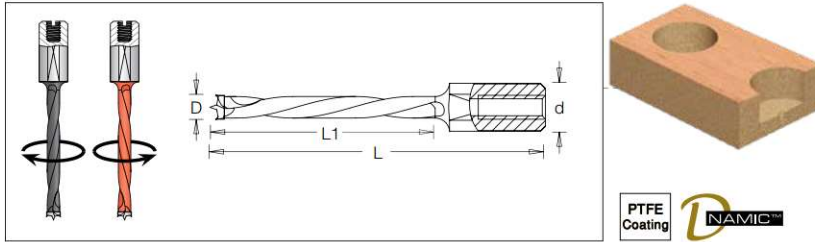

Code No.					
øD	Right	Left	L1	L	ød
5.0	2064137	2064147	35	57.5	10x20
6.0	2064277	2064267	35	57.5	10x20
8.0	2064197	2064187	35	57.5	10x20
10.0	2064217	2064237	35	57.5	10x20

Code No.					
øD	Right	Left	L1	L	ød
5.0	2064047	2064087	45	70	10x20
6.0	2064077	2064097	45	70	10x20
8.0	2064057	2064107	45	70	10x20
10.0	2064067	2064117	45	70	10x20

Code No.					
øD	Right	Left	L1	L	ød
5.0	2064127	2064157	50	77	10x20
6.0	2064247	2064257	50	77	10x20
8.0	2064167	2064177	50	77	10x20
10.0	2064207	2064227	50	77	10x20



Drills



CNC & Automatic Machines

201 Bk - Through Hole Drilling

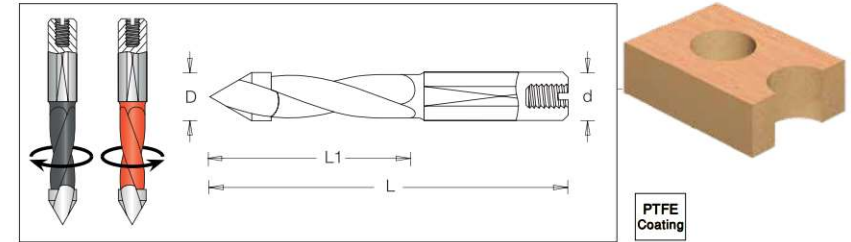

Code No.					
øD	Right	Left	L1	L	ød
4.0	2016007	2016017	25	57.5	10x25
5.0	2016047	2016057	25	57.5	10x25
6.0	2016067	2016077	25	57.5	10x25
7.0	2016507	2016517	25	57.5	10x25
10.0	2016127	2016137	25	57.5	10x25



201 Bk - Through Hole Drilling

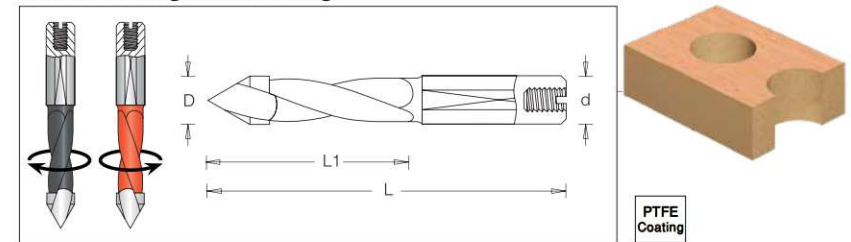

Code No.					
øD	Right	Left	L1	L	ød
5.0	2016147	2016157	40	70	10x25
6.0	2016167	2016177	40	70	10x25
7.0	2016617	2016627	40	70	10x25
8.0	2016187	2016197	40	70	10x25
9.0	2016677	2016687	40	70	10x25
10.0	2016227	2016237	40	70	10x25
12.0	2016867	2016877	40	70	10x25



Drills



CNC & Automatic Machines



Multi Purpose Boring



Slot Mortising



Counter Sinking & Plug maker



Dirose

Drills



CNC & Automatic Machines



Multi Purpose Boring



Slot Mortising



Counter Sinking & Plug maker



Dirose

Drills

CNC & Automatic Machines

201 Bk - Through Hole Drilling

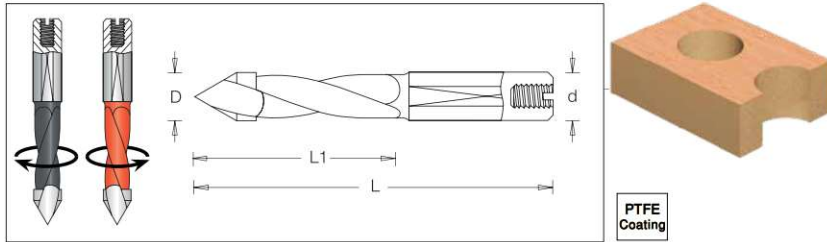

øD	Code No.		L1	L	ød
	Right	Left			
5	2016247	2016257	45	77	10x25
6	2016267	2016277	45	77	10x25
7	2016317	2016327	45	77	10x25
8	2016287	2016297	45	77	10x25
9	2016377	2016387	45	77	10x25
10	2016417	2016427	45	77	10x25



201 Bk - Through Hole Drilling 8mm Shank

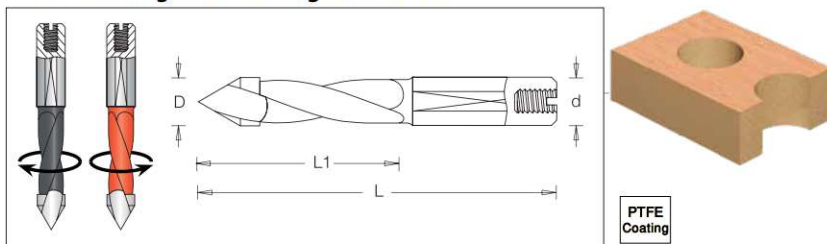

øD	Code No.		L1	L	ød
	Right	Left			
5	2016045	2016055	25	55.5	8x20



Drills

CNC & Automatic Machines

Ditec™ Dowel Drill

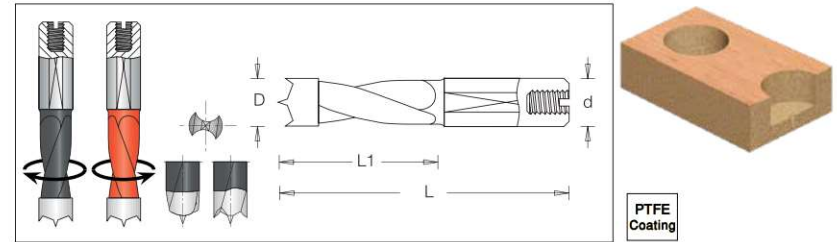

øD	Code No.		L1	L	ød
	Right	Left			
5.0	2017057	2017067	27	57.5	10x25
8.0	2017137	2017167	27	57.5	10x25
10.0	2017227	2017237	27	57.5	10x25
5.0	2017317	2017347	35	70	10x25
8.0	2017437	2017467	35	70	10x25
10.0	2017457	2017487	35	70	10x25



Ditec™ Through Hole Drilling

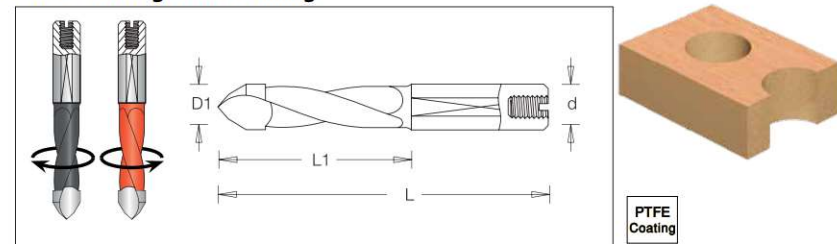

øD	Code No.		L1	L	ød
	Right	Left			
5.0	2017607	2017617	27	57.5	10x25
8.0	2017627	2017637	27	57.5	10x25
10.0	2017647	2017657	27	57.5	10x25
5.0	2017707	2017717	35	70	10x25
8.0	2017727	2017737	35	70	10x25
10.0	2017747	2017757	35	70	10x25



CNC & Automatic Machines



Multi Purpose Boring



Slot Mortising



Counter Sinking & Plug maker



Dirose



CNC & Automatic Machines



Multi Purpose Boring



Slot Mortising



Counter Sinking & Plug maker



Dirose

Drills

CNC & Automatic Machines

Ditec™ Solid Carbide Dowel Drill

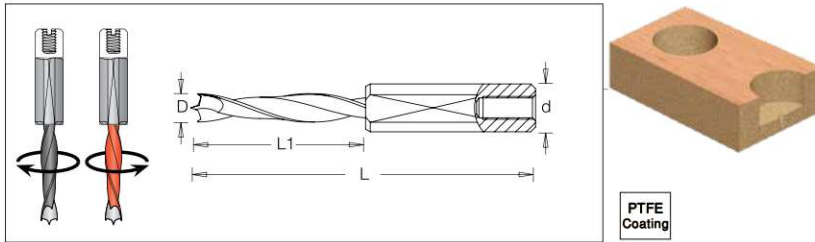

øD	Code No.		L1	L	ød
	Right	Left			
3.0	2060007	2060017	25	57.5	10x25
5.0	2060037	2061107	25	57.5	10x25
8.0	2060067	2061097	25	57.5	10x25
3.0	2061137	2061147	40	70	10x25
4.0	2060087	2061127	40	70	10x25
5.0	2060097	2064017	40	70	10x25
8.0	2060127	2064037	40	70	10x25



Ditec™ Solid Carbide Through Hole Drilling

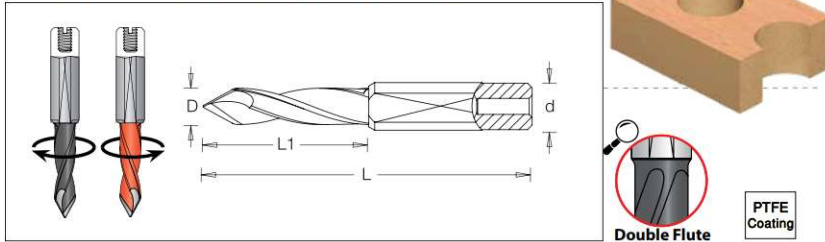

øD	Code No.		L1	L	ød
	Right	Left			
4.0	2061007	2061117	40	70	10x25
5.0	2061017	2061047	40	70	10x25
8.0	2061037	2061067	40	70	10x25



TBOX
Darbagaldi & Instrumenti

Drills

CNC & Automatic Machines

203 Bk - Cylinder Boring Bit - Combi System

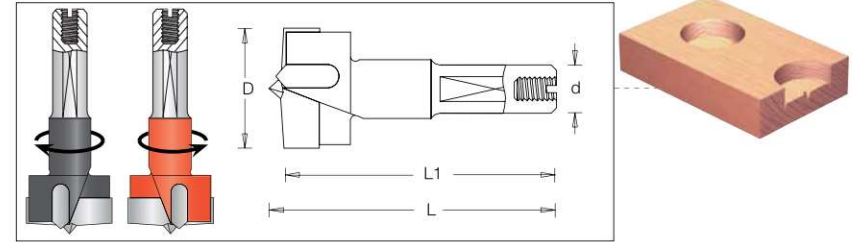

øD	Code No.		L1	L	ød
	Right	Left			
15.0	2031007	2031087	55.5	57.5	10x26
16.0	2031367	2031377	55.5	57.5	10x26
18.0	2031027	2031097	55.5	57.5	10x26
20.0	2031017	2031047	55.5	57.5	10x26
22.0	2031037	2031057	55.5	57.5	10x26
25.0	2031077	2031107	55.5	57.5	10x26
26.0	2031137	2031167	55.5	57.5	10x26
28.0	2031157	2031177	55.5	57.5	10x26
30.0	2031197	2031227	55.5	57.5	10x26
35.0	2031257	2031287	55.5	57.5	10x26
38.0	2031267	2031277	55.5	57.5	10x26
40.0	2031317		55.5	57.5	10x26



øD	Code No.		L1	L	ød
	Right	Left			
15	2031407	2031417	68	70	10x26
20	2031427	2031437	68	70	10x26
25	2031447	2031457	68	70	10x26
30	2031467	2031477	68	70	10x26
35	2031487	2031497	68	70	10x26
35	2031517		75	77	10x26



TBOX
Darbagaldi & Instrumenti



Drills

CNC & Automatic Machines

203 T - Combi Chuck

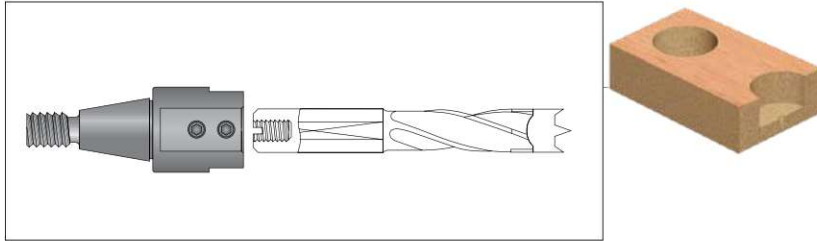

For Machines	øD	Code No.		M	L1	L	ød
		Right	Left				
Nottmeyer	20	2039015	2039045	8	15	40	10
	20	2039065	2039075	8	16	41	10
Vitap, Busselato, Ompex	20	2039207	2039237	10	12	47	10
Ayen, Torwegge, Holzma	20	2039407	2039437	10	15	40	10
Holzma, SCM Morbidelli, Biesse, Torwegge	20	2039307	2039337	10	16	41	10
Scheer	20	2039607	2039637	10		46	10

⚠ Advanced chuck system replacing thread-shank tools. Suitable for most automatic multi-spindle drilling machines.

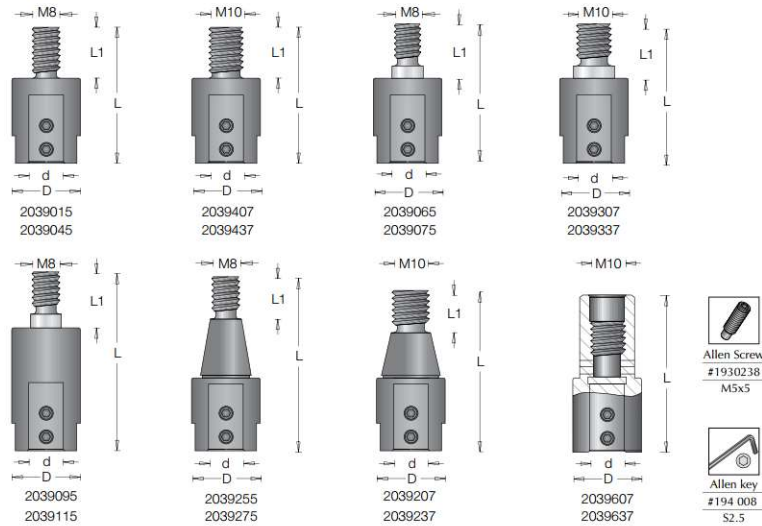

Drills

CNC & Automatic Machines

Reduction Bushing for Combi Chuck

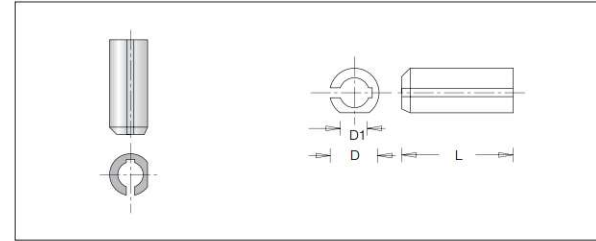

øD1	øD	Code No.	L
2.0	10	1924560	23
2.5	10	1924570	23
3.0	10	1924510	23
3.2	10	1924580	23
3.5	10	1924520	23
4.0	10	1924530	23
5.0	10	1924540	23
6.0	10	1924600	23
7.0	10	1924610	23
8.0	10	1924550	23

⚠ To use with solid HM or HSS Drills. Adapts to combi chuck with two tightening screws.

2039 - Chuck Adapter for Solid HM Or HSS Drills

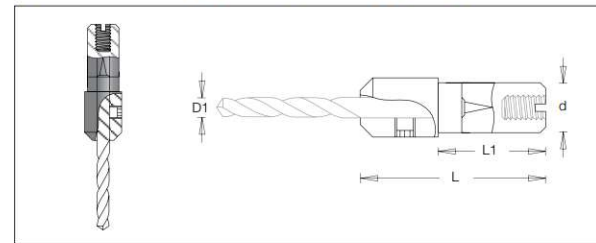

øD1	Code No.	L1	L	ød
2.0	2039507	22	38	10
2.5	2039517	22	38	10
3.0	2039527	22	38	10
3.2	2039537	22	38	10
3.5	2039547	22	38	10
4.0	2039557	22	38	10
5.0	2039567	22	38	10



Drills

CNC & Automatic Machines

2022 - Countersink for Dowel Drills

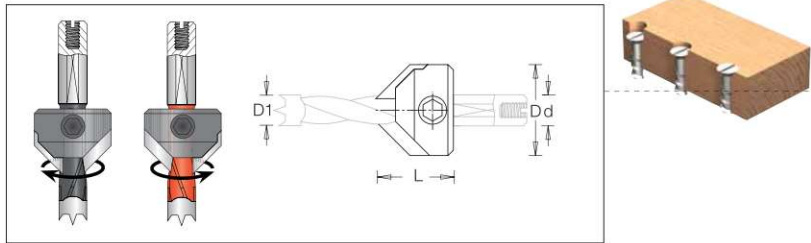

Code No.		Right	Left	L1	ød
øD1	ød				
4.0	15.6	2022020	2022030	17.5	4
5.0	16.0	2022000	2022010	17.5	5
6.0	16.0	2022040	2022050	17.5	6
7.0	16.0	2022060	2022070	17.5	7
8.0	18.0	2022100	2022110	17.5	8
9.0	18.0	2022140	2022150	17.5	9
10.0	20.0	2022200	2022210	17.5	10
12.0	20.0	2022240	2022250	18.0	12
5-10	15.5	2022260*	2022270*	16.5	10
5-10	20.0	2022300*	2022310*	17.5	10

* This countersink is assembled on the shank of the drill. Series of countersinks suitable for dowel drills.

Screw
#193 000 0
M5x10

2034 Cylinder Boring Bit For Router Machine

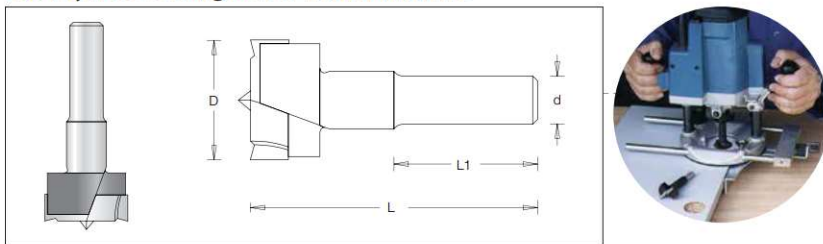

øD	Code No.	L1	L	ød
25	2038055	30	60	8
30	2034465	30	60	8
30	2034469	30	60	12
35	2034515	30	60	8
35	2034519	30	60	12

Specially designed drills for high rotation speed. Suitable for covered board and natural wood.

Drills

Multi Purpose Boring

203 BM - Adjustable Cylinder Boring Bit for Bench Drilling Machine

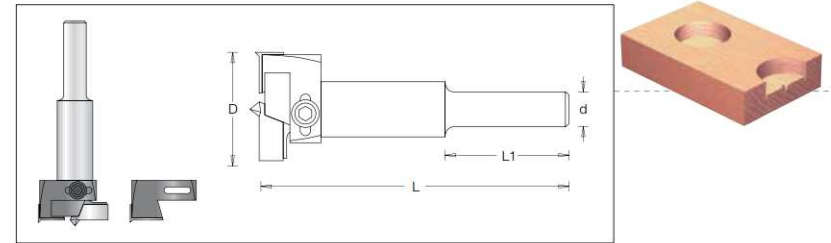

Code No.	L1	L	ød		
Complete	30.0-60.0	2035017	35	90	10

With centering point two scorers, one fixed and one adjustable. Supplied with adjustable knife for range 30-45 mm. Additional knife for the 45-60 mm range and matching hexagon key.

Knife #203 512 0 30-45	Knife #203 520 0 45-60	Allen screw #193 013 0 4.8x16	Allen key #194 010 0 5/32

203 BM - Adjustable Cylinder Boring Bit for Bench Drilling Machine

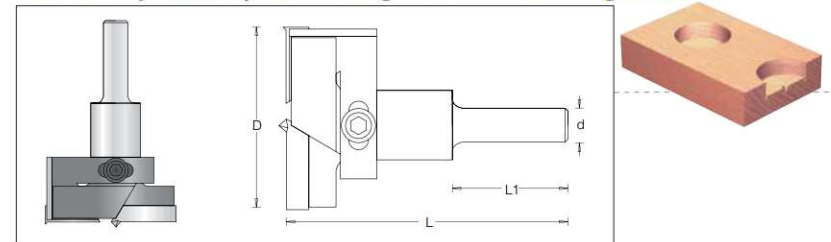

Code No.	L1	L	ød		
Complete	60.0-80.0	2035048	40	100	12.7

With centering point two scorers, one fixed and one adjustable covering the range of 60-80 mm. Supplied with matching hexagonal key.

Spare Parts: Knife #203 525 0 60-80	Allen screw #193 010 0 6.3x19	Allen key #194 007 0 3/16



Drills

Multi Purpose Boring

203 B Cylinder Boring Bit

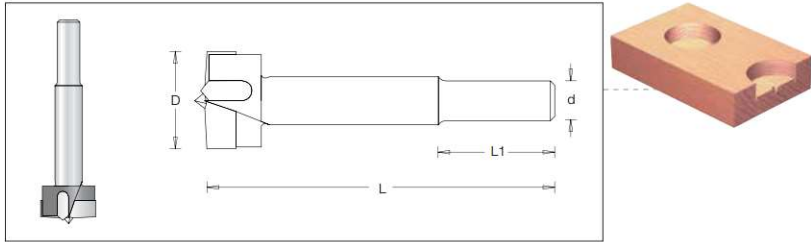

øD	Code No.	L1	L	ød
8	2033087	30	90	10
10	2033107	30	90	10
12	2033127	30	90	10
13	2033137	30	90	10
14	2033147	30	90	10
15	2033157	30	90	10
16	2033167	30	90	10
17	2033177	30	90	10
18	2033187	30	90	10
19	2033197	30	90	10
20	2033207	30	90	10
21	2033217	30	90	10
22	2033227	30	90	10
23	2033237	30	90	10
24	2033247	30	90	10
25	2033257	30	90	10
26	2033267	30	90	10
27	2033277	30	90	10
28	2033287	30	90	10
29	2033297	30	90	10
30	2033307	30	90	10
31	2033317	30	90	10
32	2033327	30	90	10
33	2033337	30	90	10
34	2033347	30	90	10
35	2033357	30	90	10
36	2033367	30	90	10
37	2033377	30	90	10
38	2033387	30	90	10
39	2033397	30	90	10
40	2033407	30	90	10
42	2033427	38	90	10
45	2033457	38	90	10
48	2033487	38	90	10
50	2033507	38	90	10
55	2033557	38	90	10
58	2033587	38	90	10
60	2033607	38	90	10

Drills

Counter Sinking & Plug maker

Joining Wood with Screws

When joining 2 pieces of wood using screws, it is essential to pre-drill and countersink in order to achieve an esthetic and long lasting finish.

- **Pilot hole - in the bottom board.**
The pilot hole diameter should roughly match the root diameter of the screw. It can be slightly smaller for softwood. The clearance hole should be slightly larger than the diameter of the threads. For decking jobs, it is not usually necessary to pre-drill the bottom board, as it will always be hidden from view.
- **Clearance hole and Countersink - in the top board.**
The pilot hole diameter should roughly match the root diameter of the screw. It can be slightly smaller for softwood. The clearance hole should be slightly larger than the diameter of the threads. For decking jobs, it is not usually necessary to pre-drill the bottom board, as it will always be hidden from view.

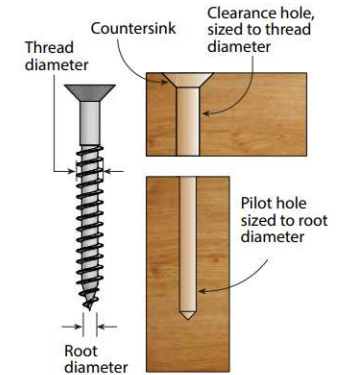

Countersink & Stop for a long lasting perfect joint.



CNC & Automatic Machines



Multi Purpose Boring



Slot Mortising



Counter Sinking & Plug maker



Dirose



CNC & Automatic Machines



Multi Purpose Boring



Slot Mortising



Counter Sinking & Plug maker



Dirose

TBOX

Darbagaldi & Instrumenti

Drills

Counter Sinking & Plug maker

For Clean Surface and Simple Depth Control. No Scratches! No Burn Marks!

Unique adjustable depth-stops, developed for quick and easy adjustment of the countersink depth. The user-friendly design enables easy control of the drill length and its replacement. Disassembly of the Depth-Stop is not needed. Special double-sided hex key (1/8" x 4) included.

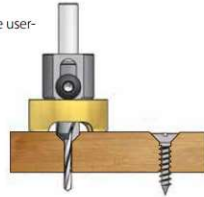

Countersink with Low Friction Depth-Stop

Antifriction polymer collar. 1/4" HEX shank. Slow Spiral HSS drill included.

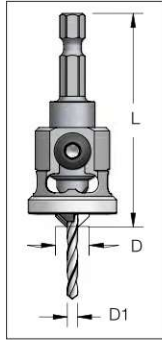

D1	D	Code No.	L
3.2	9.5	2027050	60
3.6	12.7	2027060	60
4.0	9.5	2027070	60
5.0	12.7	2027100	70
6.0	12.7	2027110	70



Countersink with Low Friction Depth-Stop

Antifriction polymer collar. Round shank. Slow Spiral HSS drill included.

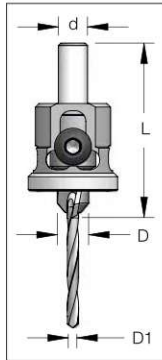

D1	D	Code No.	L	d
3.2	9.5	2027635	49	8
3.2	12.7	2027645	51	8
4.0	10	2027675	50	8
4.8	12.7	2027706	51	9.5
5.0	12	2027726	51	9.5
6.0	12.7	2027736	51	9.5



TBOX
Darbagaldi & Instrumenti



Drills

Counter Sinking & Plug maker

Countersink with Depth Stop-PRO

Non-Friction metal stopper with thrust ball bearing. Assures a strong and long lasting tool. Efficient and easy chip evacuation Quick-Change 1/4" (6.3mm) HEX shank. HSS drill included.

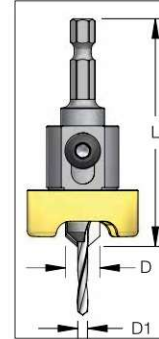

D1	D	Code No.	L
3.2	9.5	2027210	66
3.6	9.5	2027220	66
4.0	9.5	2027230	66
4.4	12.7	2027240	70



Countersink with Depth Stop-PRO

Non-Friction metal stopper with thrust ball bearing. Assures a strong and long lasting tool. Efficient and easy chip evacuation Quick-Change 1/4" (6.3mm) HEX shank. HSS drill included.

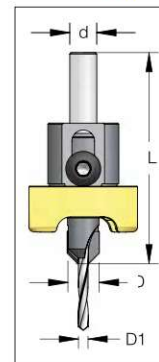

D1	D	Code No.	L	d
5.0	12	2020917	65	10
6.0	12.7	2020927	65	10



TBOX
Darbagaldi & Instrumenti



CNC & Automatic Machines



Multi Purpose Boring



Slot Mortising



Counter Sinking & Plug maker



Dirose



CNC & Automatic Machines



Multi Purpose Boring



Slot Mortising



Counter Sinking & Plug maker



Dirose

Drills

Counter Sinking & Plug maker

Carbide Tipped Countersink

Slow Spiral HSS drill included.
Round shank.

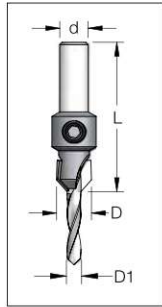

D1	D	Code No.	L	ød
2.4	8.0	2021250	43	8.0
3.2	8.0	2021280	43	8.0
3.2	9.5	2021300	44	8.0
3.2	12.7	2021330	43	8.0
3.6	10.0	2021350	43	8.0
4.0	10.0	2021400	43	8.0
4.4	10.0	2021450	49	8.0
4.8	12.7	2021550	47	9.5
5.0	12.0	2021580	51	9.5
5.6	12.7	2021530	49	9.5
6.0	12.7	2021600	47	9.5
6.3	12.7	2021650	47	10.0
6.3	13.5	2021630	47	10.0



Drills

Counter Sinking & Plug maker

Carbide Tipped Countersink

Taper Point HSS drill included.
Round shank.

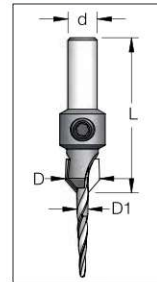

D1	D	Code No.	L	ød
3.2	9.5	2021300	44	8.0



Drills

Drills



CNC & Automatic Machines

Carbide Tipped Countersink

Stepped HSS drill included. Round shank.

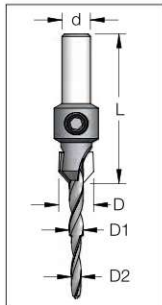

D1	D2	D	Code No.	L	ød
3.6	2.4	10.0	2022515	44	8.0
5.0	3.5	12.0	2022546	51	9.5



Carbide Tipped Counterbore (Flat Bottom)

Slow Spiral HSS drill included. Round shank.

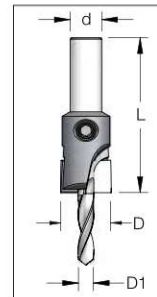

D1	D	Code No.	L	ød
3.2	9.5	2022705	48	8.0
4.8	12.7	2022736	48	9.5
5.6	12.7	2022746	48	9.5
6.0	12.7	2022756	48	9.5
6.3	12.7	2022766	48	9.5



Multi Purpose Boring



Slot Mortising



Counter Sinking & Plug maker



CNC & Automatic Machines



Multi Purpose Boring



Slot Mortising



Counter Sinking & Plug maker



Dirose

TBOX
Darbagaldi & Instrumenti

TBOX
Darbagaldi & Instrumenti

Drills

Counter Sinking & Plug maker

Carbide Tipped Countersink

HSS drill included. Quick-Change 1/4" (6.3mm) HEX shank.

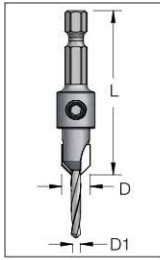

D1	D	Code No.	L
2.4	9.5	2020410	54
2.8	9.5	2020430	54
3.2	9.5	2020150	54
3.6	12.7	2020450	54
4.0	9.5	2020460	54
4.8	12.7	2020470	70
5.0	12.7	2020480	70
6.0	12.7	2020490	70
6.0	15.0	2020500	70



Carbide Tipped Counterbore

Slow Spiral HSS drill included.
Quick-Change 1/4" (6.3mm) HEX shank.

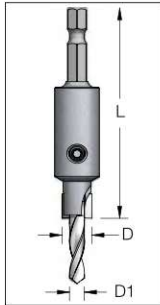

D1	D2	Code No.	L
4.8	12.7	2020560	70
6.3	12.7	2020590	70



3 Steps Drill for Laminated Chipboard

Countersink *DHN treated. Slow Spiral HSS drill included. Round shank.

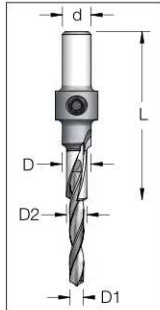

D1	D2	D	Code No.	L	ød
3.5	5.0	7.0	2026057	60	10
5.0	7.0	10.0	2026107	60	10

* DHN - Advanced surface treatment for extended life

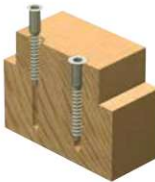

Drills

Counter Sinking & Plug maker

Dicount - Multi Diameter Countersink

Slow Spiral HSS drill included.
One tool fits over drills of different sizes

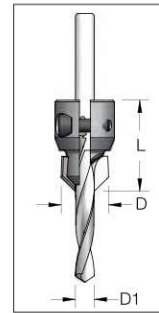

D1	D	Code No.	L
3.0 - 7.2	11.3 - 15.3	2020000	32



Carbide Tipped Countersink

Slow Spiral HSS drill included.
Round shank.

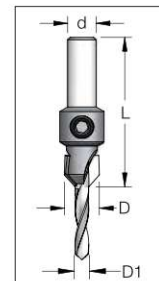

D1	D	Code No.	L	ød
3.0	10	2022305	48	8
3.2	10	2022325	48	8
3.5	10	2022355	48	8
3.6	10	2022365	48	8
4.0	10	2022405	48	8
4.4	10	2022455	48	8
5.0	10	2022505	48	8



Plug Cutters - Self Ejecting

Heat-treated and DHN treated.
One Flute. For best results use drill press.
Quick-Change 1/4" (6.3mm) HEX Shank.

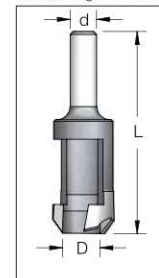

D1	Code No.	L	ød
9.5	2034055	61	8
10.0	2034015	61	8
12.0	2034065	61	8
12.7	2034025	61	8
16.0	2034037	75	10
19.0	2034047	75	10



CNC & Automatic Machines



Multi Purpose Boring



Slot Mortising



Counter Sinking & Plug maker



Dirose



CNC & Automatic Machines



Multi Purpose Boring



Slot Mortising



Counter Sinking & Plug maker



Dirose

Drills

Counter Sinking & Plug maker

Countersink & Plug Set

Includes TCT countersink bits with different drill diameters and a 10mm plug cutter, which fits with all countersinks.

Round shanks 8mm.



øD	D	Set No.
3.5	10	2023355
4.0	10	2023405
5.0	10	2023505



Drills



CNC & Automatic Machines



Multi Purpose Boring



Slot Mortising



Counter Sinking & Plug maker



Dirose

Carbide Tipped Plug Cutters - 2 flutes

Drill press must be used.
For making plugs up to 16mm Long.

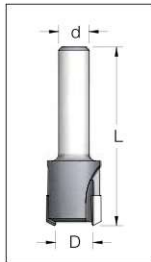

D1	Code No.	L	ød
9.5	2020603	58	6
12.7	2020659	65	12



TBOX

Darbagaldi & Instrumenti

Drills

Counter Sinking & Plug maker

HSS Drills

DIN 338. M2 Fully ground. Round shanks 8mm.

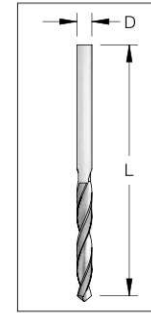

øD	Set No.	L
3.2	440071	65
3.6	440082	70
4.0	440094	75
4.8	440119	86
5.0	440125	86
5.6	440143	93
6.0	440155	93
6.3	440164	101

HSS Taper Point Drills

M2 Fully ground.
Unique solution for one drilling operation of: Pilot hole + Clearance hole.

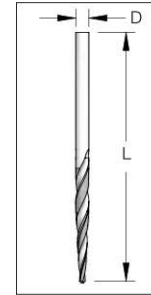

øD	Set No.	L
2.4	443001	75
3.2	443003	70
3.6	443004	73
4.0	443005	80
4.8	443007	89
5.0	443008	89
6.0	443010	98

HSS Stepped Drills

M2 Fully ground.

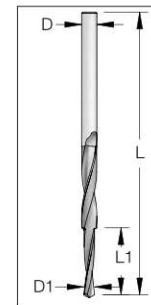

D	D1	Code No.	L	L1
2.4	3.6	445001	70	16
3.2	4.4	445003	80	22
5.0	7.1	445005	109	25

TBOX

Darbagaldi & Instrumenti

Drills



CNC & Automatic Machines



Multi Purpose Boring



Slot Mortising



Counter Sinking & Plug maker



Dirose

Drills

Dirose

Dirose™ Profile for Rosettes.

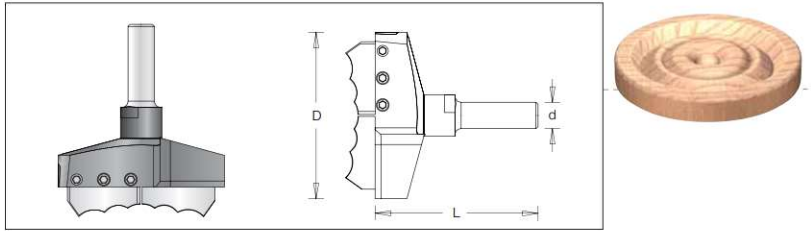

Dirose	øD	Code No.	L	ød
	79.6	1800019 ■	81	12

Spare Parts:

⚠ Check that the speed is suitable for the type of wood being worked:
 MDF: 3000-6000 RPM
 Soft Wood: 3000-6000 RPM
 Hard Wood: 1500-2000 RPM

Drills



CNC & Automatic Machines



Multi Purpose Boring



Slot Mortising



Counter Sinking & Plug maker



Dirose

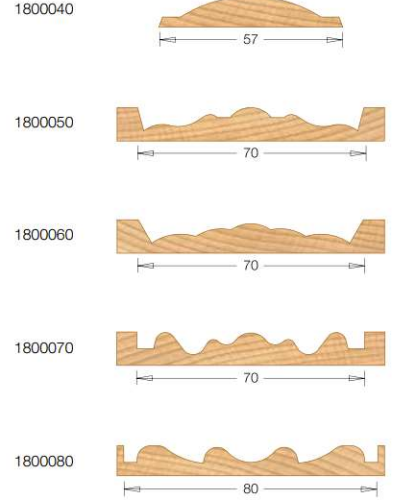
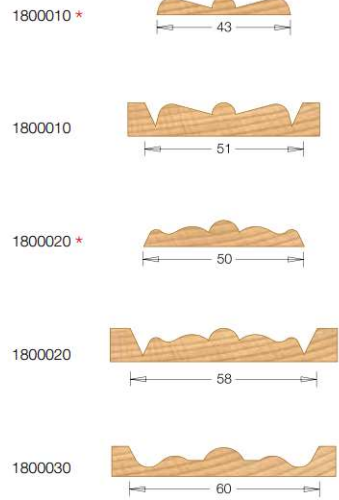

⚠ * With this knife it is possible to execute both a depressed rosette in the wood and a protruding rosette (button) for gluing.

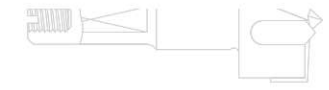

Drills

Dirose

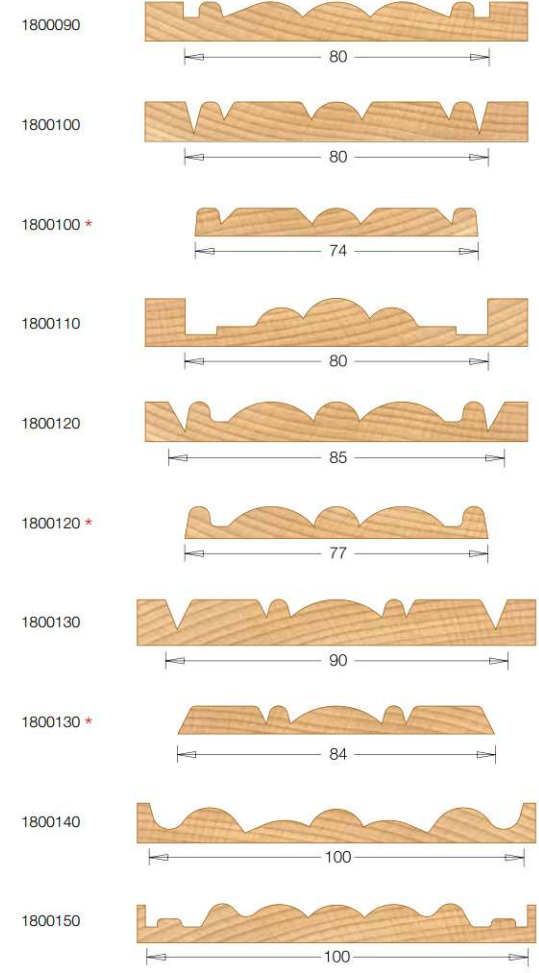

⚠ * With this knife it is possible to execute both a depressed rosette in the wood and a protruding rosette (button) for gluing.

Drills



CNC & Automatic Machines



Multi Purpose Boring



Slot Mortising



Counter Sinking & Plug maker



Dirose

Router Bits

The most comprehensive range of router bits available to the industrial and professional markets.

- Exclusive **Dnamic** grade carbide
- High quality steel alloy
- Unique grinding process enhances precision and quality

Advanced manufacturing process, using cutting-edge technology in router bit manufacturing for optimal cutting and extended tool life.

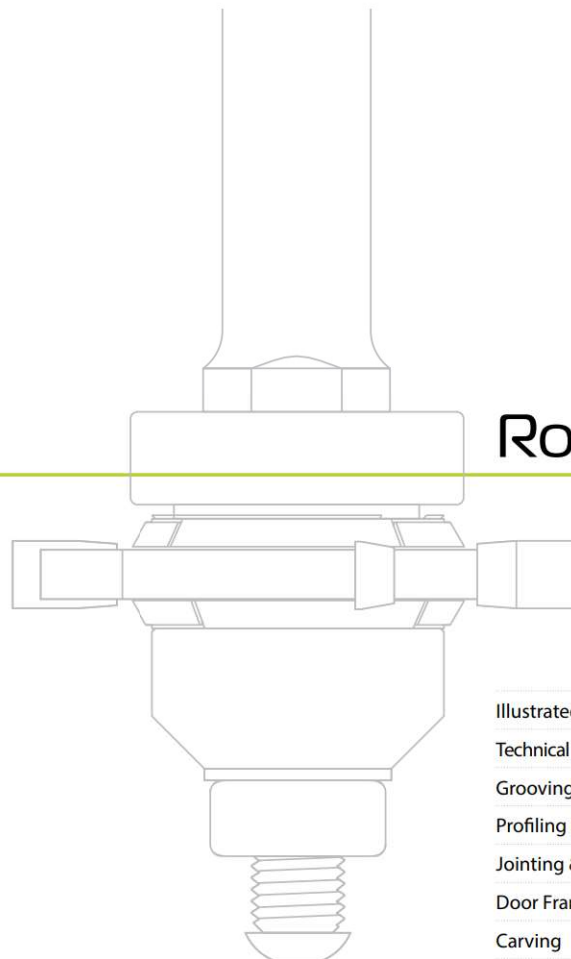

Routing INDEX

Illustrated Visual Index	228	230
Technical Information	231	
Grooving & Sizing	232	- 253
Profiling & Chamfering	254	- 296
Jointing & Rebating	300	- 306
Door Frame & Panel	307	- 322
Carving	323	
Ball Bearing Parts	324	- 325



Grooving & Sizing



Profiling & Chamfering



Jointing & Rabbeting



Door Frame & Panel



Carving